

## PROTEÇÃO

Ex d e – Ex tb ZONAS: 1, 2 – 21  
e 22 GRUPOS: IIC – IIIC

## CLASSE DE TEMPERATURA

TPEX 251-16A

T6 / T85°C [-40°C ≤ TAMB ≤ +45°C] T5 /  
T85°C [-40°C ≤ TAMB ≤ +55°C]

TPEX 252-32A

T6 / T85°C [-40°C ≤ TAMB ≤ +40°C] T5 /  
T85°C [-40°C ≤ TAMB ≤ +55°C]

TPEX 253-63A\*

T6 [-40°C ≤ TAMB ≤ +40°C] T5 [-  
40°C ≤ TAMB ≤ +55°C]

TPEX 254-125A\*

T5 [-40°C ≤ TAMB ≤ +45°C] EPL: Gb  
– Db

## GRAU DE PROTEÇÃO

IP66

## NORMALIZAÇÃO APLICÁVEL

ABNT NBR IEC 60079-0 | ABNT NBR IEC 60079-1 ABNT  
NBR IEC 60079-7 | ABNT NBR IEC 60079-31

## DESCRIÇÕES TÉCNICAS

- Tomada fabricada em **poliéster** reforçado com **fibra de vidro**.
- Plugue fabricado em **poliamida**.
- Para fazer o acionamento, girar o plugue.
- Frequência: **50/60 Hz**.



## TOMADAS E PLUGUES 25116A - 3 PÓLOS



Tomada  
sobrepor



Tomada  
embutir



Tomada  
móvel



Plugue



Plugue com  
protetor

REFERÊNCIA	MODELO	POLARIDADE	TENSÃO	CORRENTE	PESO (kg)	ESQUEMA ELÉTRICO	
57651/434	Tomada sobrepor	1P+N+T	110-130V	16A	1,20Kg		
57651/834	Tomada embutir	2P+T			0,40Kg		
57651/334	Tomada móvel				0,70Kg		
57651/734	Plugue				0,35Kg		
57651/034	Plugue com protetor		0,37Kg				
57651/436	Tomada sobrepor	1P+N+T	200-250V	16A	1,20Kg		
57651/836	Tomada embutir	2P+T			0,40Kg		
57651/336	Tomada móvel				0,70Kg		
57651/736	Plugue				0,35Kg		
57651/036	Plugue com protetor				0,37Kg		

Tomada sobrepor: fornecida com um prensa-cabo M25 (Ø8-17 mm).

Tomada móvel: faixa de aperto para cabo de Ø6,5-18,5 mm.

Plugues: faixa de aperto para cabo de Ø6,5-18,5 mm.

## DIMENSÕES EXTERNAS

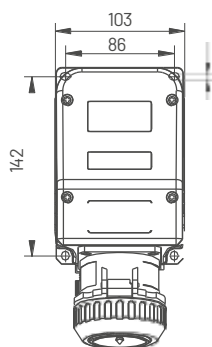

Tomada sobrepor

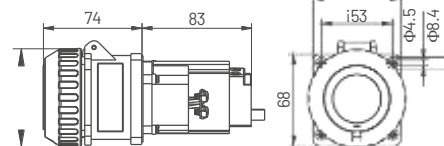
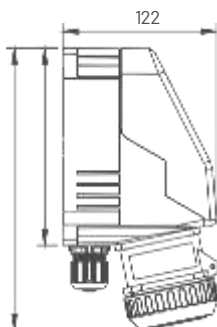

Tomada embutir

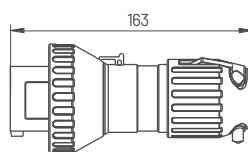

Plugue

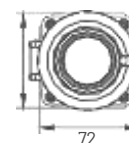
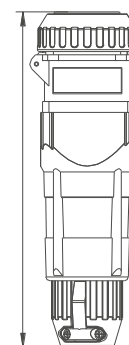
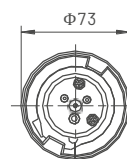

Tomada móvel

## TOMADAS E PLUGUES 25116A - 4 E 5 PÓLOS



Tomada  
sobrepor



Tomada  
embutir



Tomada  
móvel



Plugue



Plugue com  
protetor

REFERÊNCIA	MODELO	POLARIDADE	TENSÃO	CORRENTE	PESO (kg)	ESQUEMA ELÉTRICO
57651/449	Tomada sobrepor	3P+T	200-250V	16A	1,20Kg	
57651/849	Tomada embutir				0,70Kg	
57651/349	Tomada móvel				0,35Kg	
57651/749	Plugue				0,37Kg	
57651/049	Plugue com protetor					
57651/446	Tomada sobrepor	3P+T	380-415V	16A	1,20Kg	3P + L1 L2 L3
57651/846	Tomada embutir				0,40Kg	
57651/346	Tomada móvel				0,70Kg	
57651/746	Plugue				0,35Kg	
57651/046	Plugue com protetor				0,37Kg	
57651/447	Tomada sobrepor	3P+T	480-500V	16A	1,20Kg	
57651/847	Tomada embutir				0,40Kg	
57651/347	Tomada móvel				0,70Kg	
57651/747	Plugue				0,35Kg	
57651/047	Plugue com protetor				0,37Kg	
57651/445	Tomada sobrepor	3P+T	600-690V	16A	1,20Kg	3P+ N + L1 L2 L3 N
57651/845	Tomada embutir				0,40Kg	
57651/345	Tomada móvel				0,70Kg	
57651/745	Plugue				0,35Kg	
57651/045	Plugue com protetor				0,37Kg	
57651/456	Tomada sobrepor	3P+N+T	200-250V 380-415V	16A	1,20Kg	
57651/856	Tomada embutir				0,40Kg	
57651/356	Tomada móvel				0,70Kg	
57651/756	Plugue				0,35Kg	
57651/056	Plugue com protetor				0,37Kg	



## TOMADAS E PLUGUES TPEX 251 16A - 4 E 5 PÓLOS

### DIMENSÕES EXTERNAS

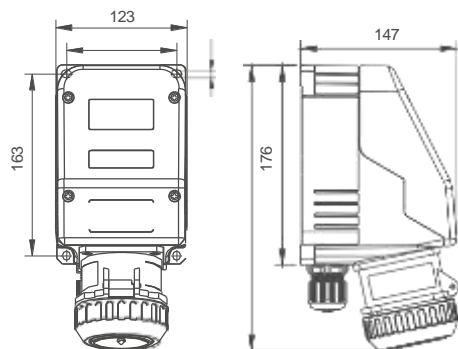

Tomada sobrepôr

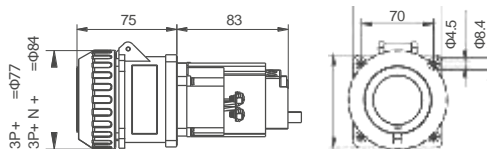

Tomada embutir

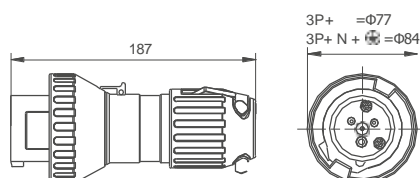

Plugue

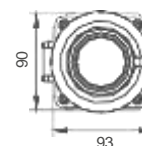
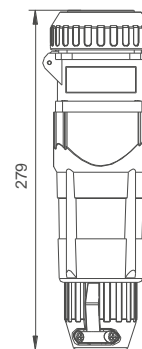

Tomada móvel

## TOMADAS E PLUGUES TPEX 252 32A - 4 E 5 PÓLOS

### DIMENSÕES EXTERNAS

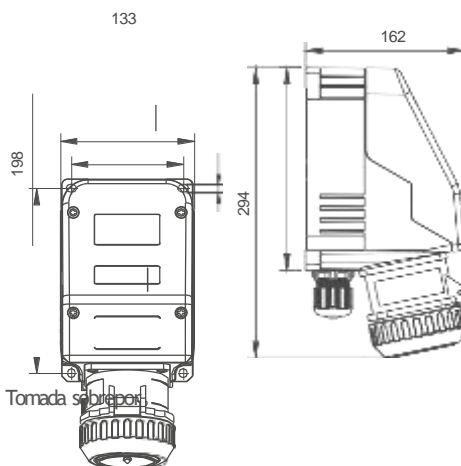

Tomada sobrepôr

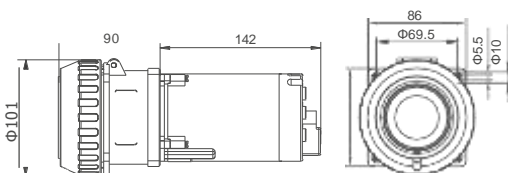

Tomada embutir

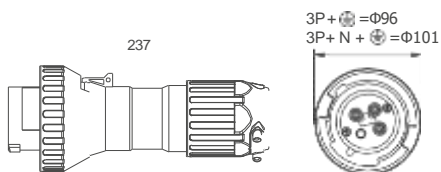

Plugue

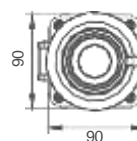
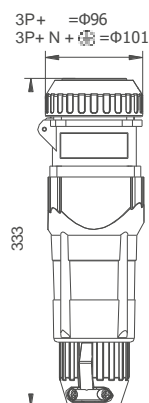

## TOMADAS E PLUGUES TPEX 252 32A - 4 E 5 PÓLOS



Tomada sobrepor



Tomada embutir



Tomada móvel



Plugue



Plugue com protetor

57652/449	Tomada sobrepor	3P+T			1,80Kg
57652/849	Tomada embutir				1,00Kg
57652/349	Tomada móvel		200-250V	32A	1,70Kg
57652/749	Plugue				0,70Kg
57652/049	Plugue com protetor				0,74Kg
57652/446	Tomada sobrepor	3P+T			1,80Kg
57652/846	Tomada embutir				1,00Kg
57652/346	Tomada móvel		380-415V	32A	1,70Kg
57652/746	Plugue			32A	0,70Kg
57652/046	Plugue com protetor				0,74Kg
57652/447	Tomada sobrepor	3P+T			1,80Kg
57652/847	Tomada embutir				1,00Kg
57652/347	Tomada móvel		480-500V	32A	1,70Kg
57652/747	Plugue			32A	0,70Kg
57652/047	Plugue com protetor				0,74Kg
57652/445	Tomada sobrepor	3P+T			1,80Kg
57652/845	Tomada embutir				1,00Kg
57652/345	Tomada móvel		600-690V	32A	1,70Kg
57652/745	Plugue			32A	0,70Kg
57652/045	Plugue com protetor				0,74Kg
57652/456	Tomada sobrepor	3P+N+T			1,80Kg
57652/856	Tomada embutir				1,00Kg
57652/356	Tomada móvel		200-250V 380-415V	32A	1,70Kg
57652/756	Plugue				0,70Kg
57652/056	Plugue com protetor				0,74Kg

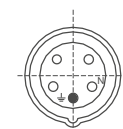
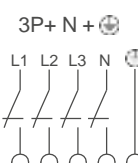
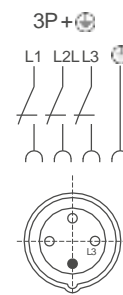

Tomada sobrepor: fornecida com um prensa-cabo M32 (Ø12-21 mm) e um bujão M32.

Tomada móvel: faixa de aperto para cabo de Ø10-28 mm.

Plugues: faixa de aperto para cabo de Ø10-28 mm.

# TOMADAS E PLUGUES À PROVA DE EXPLOÇÃO



Tomada sobrepor



Plugue



Plugue com protetor

REFERÊNCIA	MODELO	POLARIDADE	TENSÃO	CORRENTE	PESO (kg)
57653/449	Tomada sobrepor	3P+T	200-250V	63A	8,1Kg
57653/749	Plugue				0,85Kg
57653/049	Plugue com protetor				0,85Kg
57653/446	Tomada sobrepor	3P+T	380-415V	63A	8,1Kg
57653/746	Plugue				0,85Kg
57653/046	Plugue com protetor				0,85Kg
57653/447	Tomada sobrepor	3P+T	480-500V	63A	8,1Kg
57653/747	Plugue				0,85Kg
57653/047	Plugue com protetor				0,85Kg
57653/445	Tomada sobrepor	3P+T	600-690V	63A	8,1Kg
57653/745	Plugue				0,85Kg
57653/045	Plugue com protetor				0,85Kg
57653/456	Tomada sobrepor	3P+N+T	200-250V	63A	8,1Kg
57653/756	Plugue		380-415V		0,85Kg
57653/056	Plugue com protetor				0,85Kg

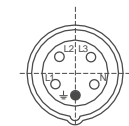
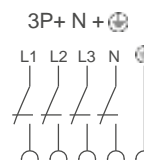
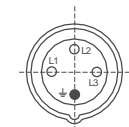
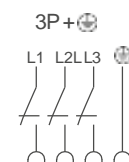

Tomada sobrepor: fornecida com um prensa-cabo M50 (Ø22-35 mm) e um bujão M50. Plugues: faixa de aperto para cabo de Ø15-35 mm.

## DIMENSÕES EXTERNAS

# TOMADAS E PLUGUES À PROVA DE EXPLOÇÃO

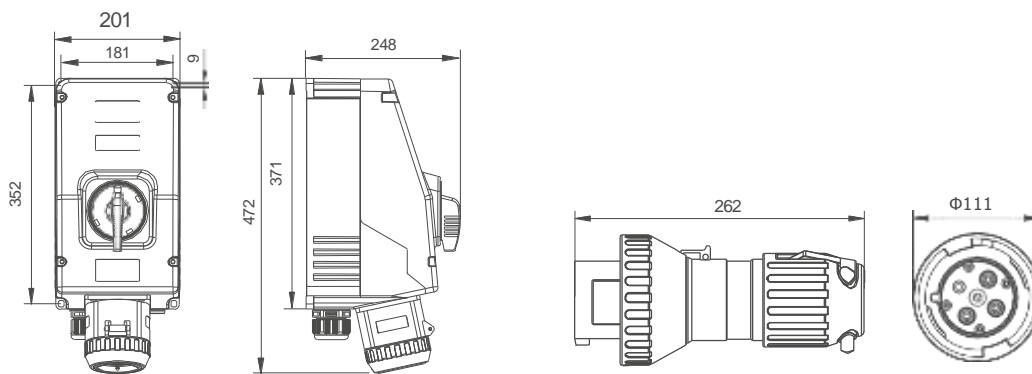

## TOMADAS E PLUGUES TPEX 254 125A - 4 E 5 PÓLOS



Tomada sobrepor



Plugue



Plugue com protetor

REFERÊNCIA	MODELO	POLARIDADE	TENSÃO	CORRENTE	PESO (kg)	ESQUEMA ELÉTRICO
57654/449	Tomada sobrepor	3P+T	200-250V	125A	13,5Kg	
57654/749	Plugue				1,3Kg	
57654/049	Plugue com protetor	9			1,3Kg	
57654/446	Tomada sobrepor	3P+T	380-415V	125A	13,5Kg	
57654/746	Plugue				1,3Kg	
57654/046	Plugue com protetor	6			1,3Kg	
57654/447	Tomada sobrepor	3P+T	480-500V	125A	13,5Kg	
57654/747	Plugue				1,3Kg	
57654/047	Plugue com protetor	7			1,3Kg	
57654/445	Tomada sobrepor	3P+T	600-690V	125A	13,5Kg	
57654/745	Plugue				1,3Kg	
57654/045	Plugue com protetor	5			1,3Kg	
57654/456	Tomada sobrepor	3P+N+T	200-250V 380-415V	125A	13,5Kg	
57654/756	Plugue				1,3Kg	
57654/056	Plugue com protetor	6			1,3Kg	



## DIMENSÕES EXTERNAS

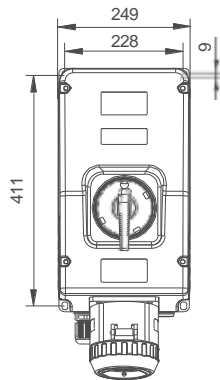

Tomada sobrepor

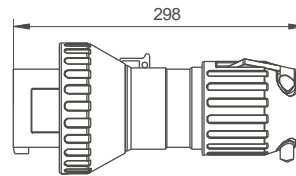
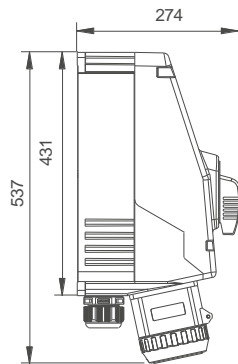

Plugue

